

TOWARD FULLPOS IN OOPS

R. El Khatib (Météo-France)

ARPEGE/IFS coordination meeting
Toulouse 06 June 2016



**METEO
FRANCE**

INTRODUCTION

The so-called « OOPSification » of the post-processing package FULLPOS aims to execute the 4DVAR assimilation inside a single executable file.

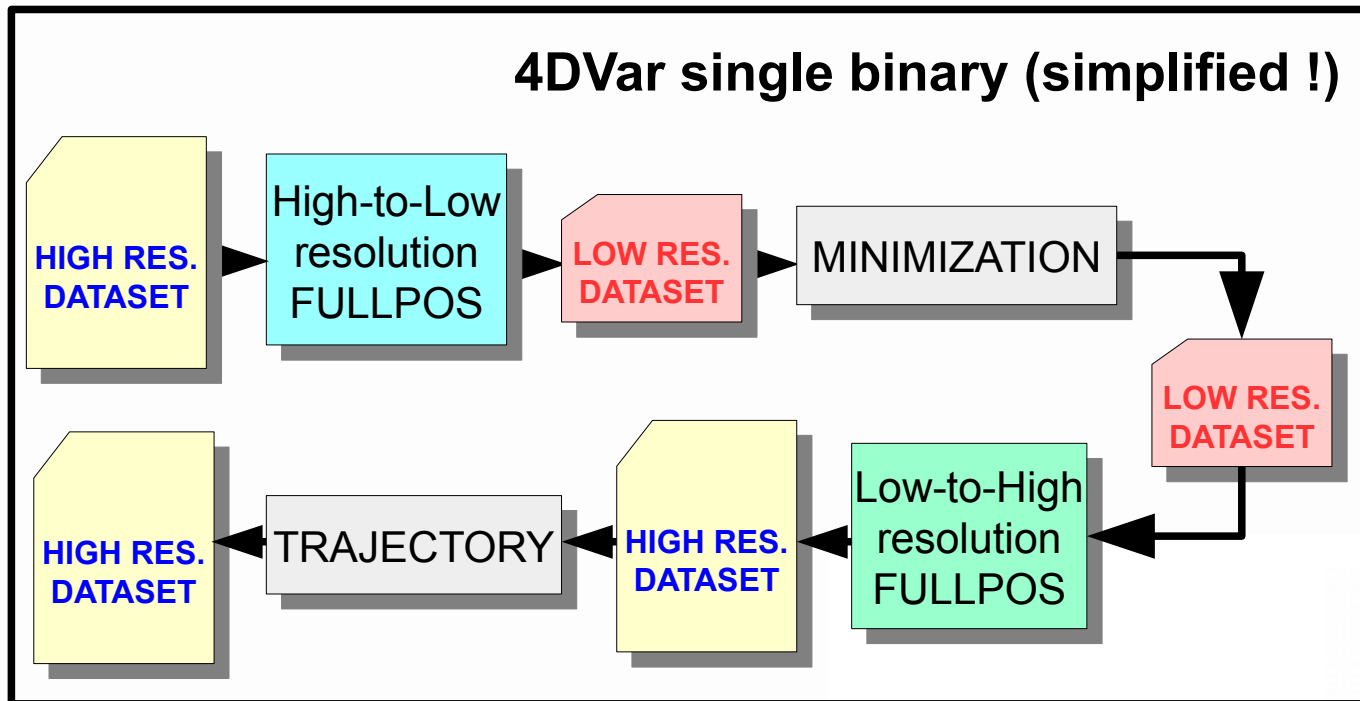

STRATEGY

Let's be pragmatic :

Progress steadily toward a complete
Object-Oriented framework for Fullpos

via intermediate steps
where the code refactoring enables

innovations to the benefit of flexibility and performance.

Here comes the configuration 903

THE CONFIGURATION 903

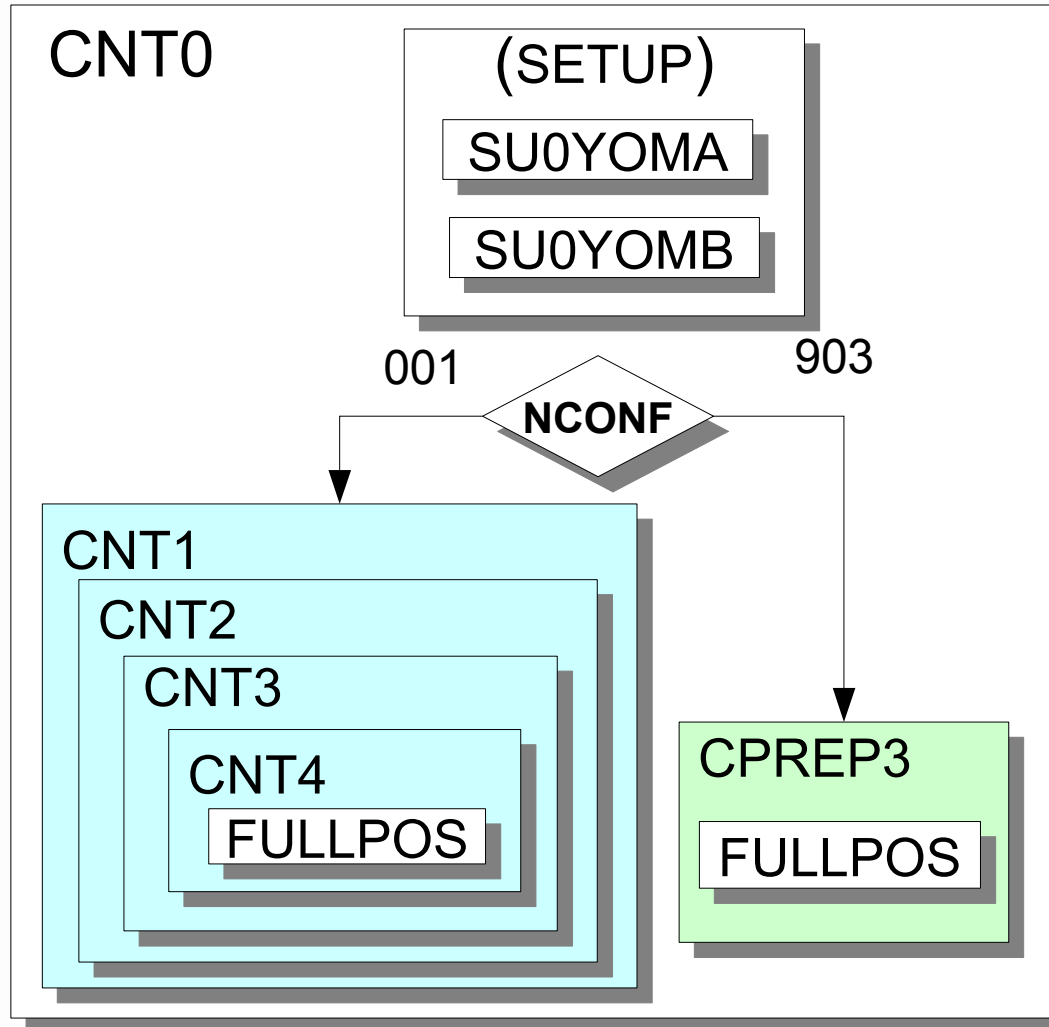

- ▶ **Off-line FULLPOS for Interoperability purposes**

- ▶ **Testbed for Fullpos in OOPS**

Configuration 903 used for Interoperability

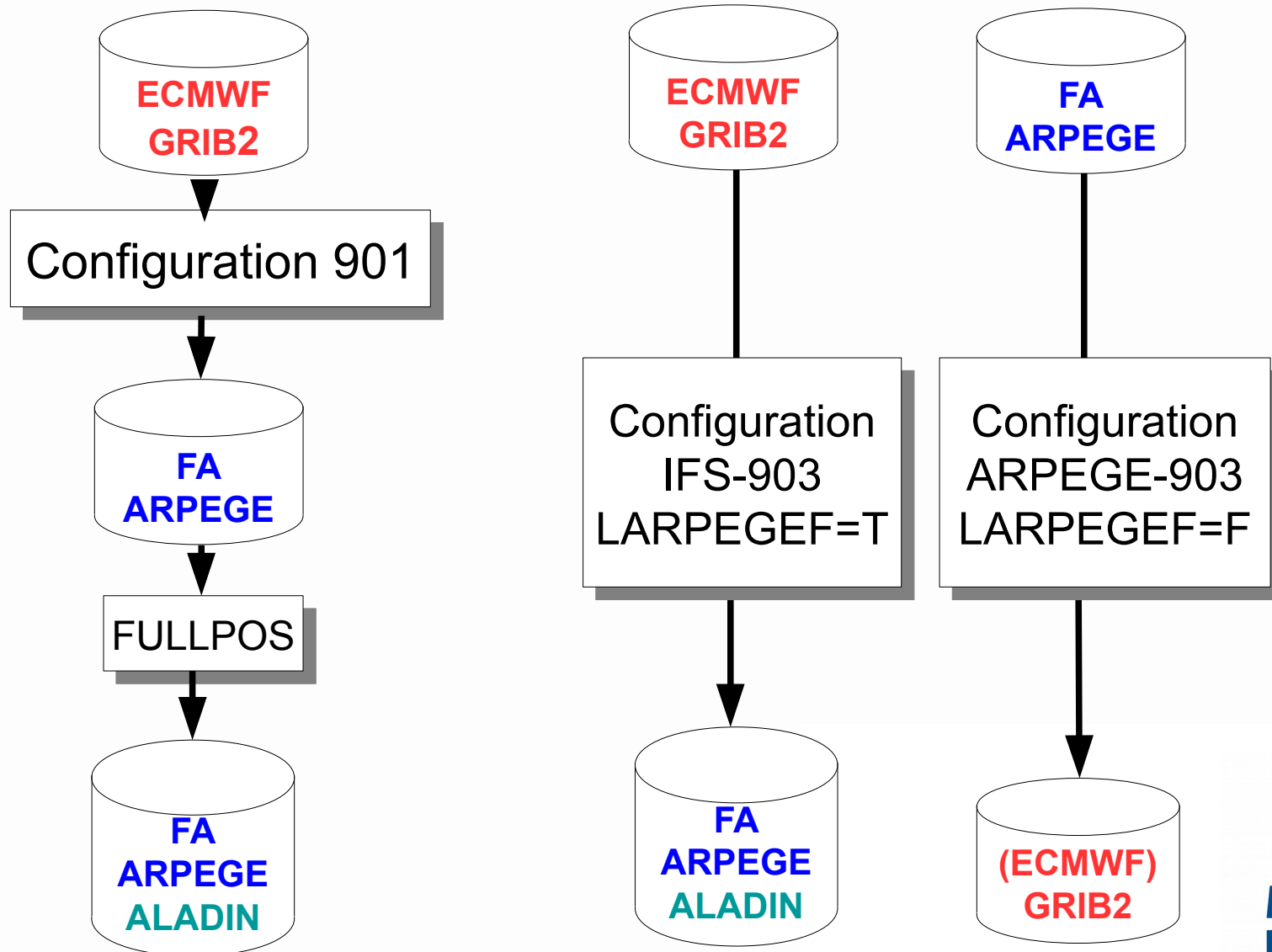

Configuration 903 as post-processing server

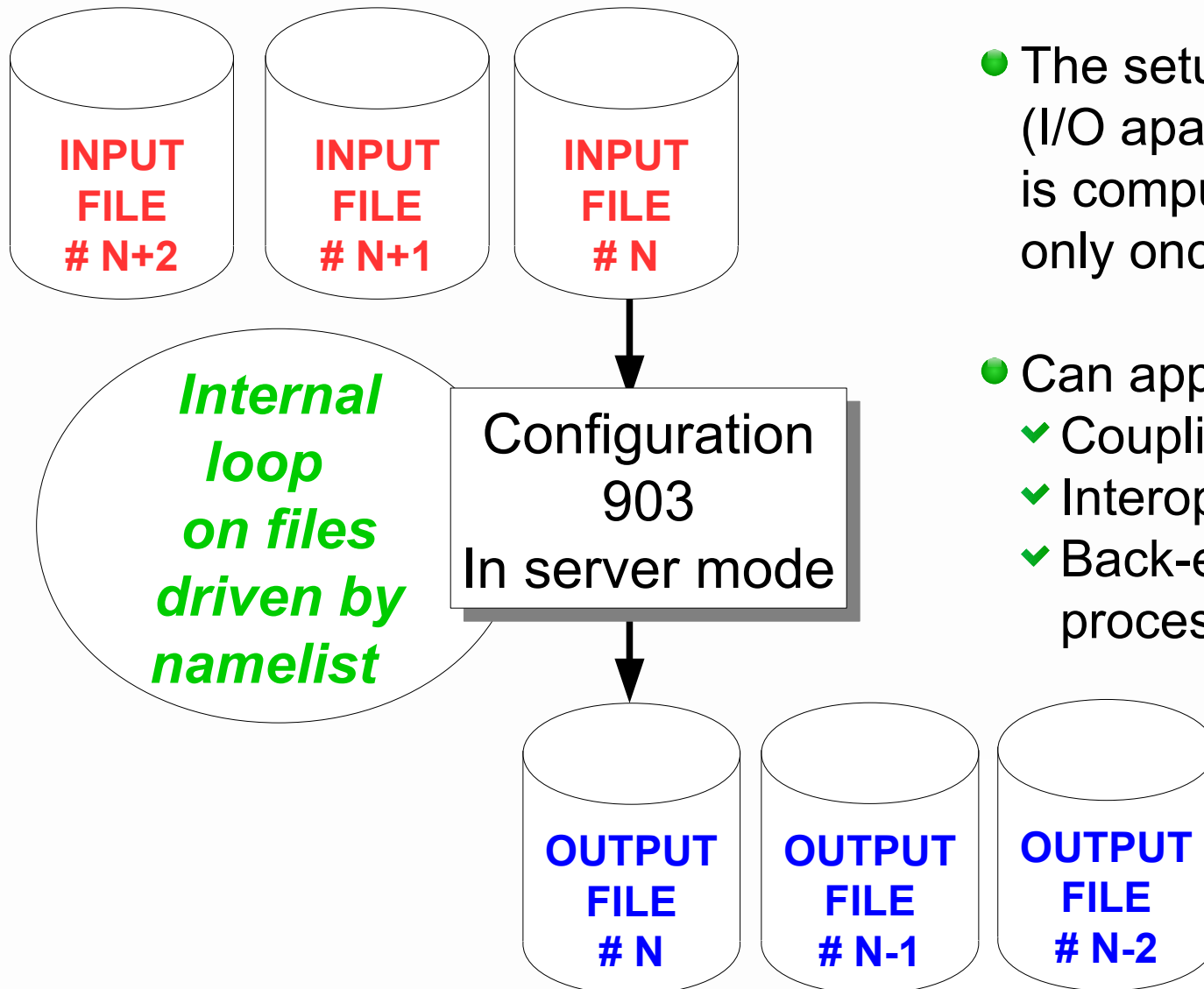

- The setup (I/O apart) is computed only once
- Can apply to :
 - ✓ Coupling files
 - ✓ Interoperability
 - ✓ Back-end post-processing

Performance of the post-processing server

Speedup by the post-processing server facility

Transformation from ARPEGE to AROME

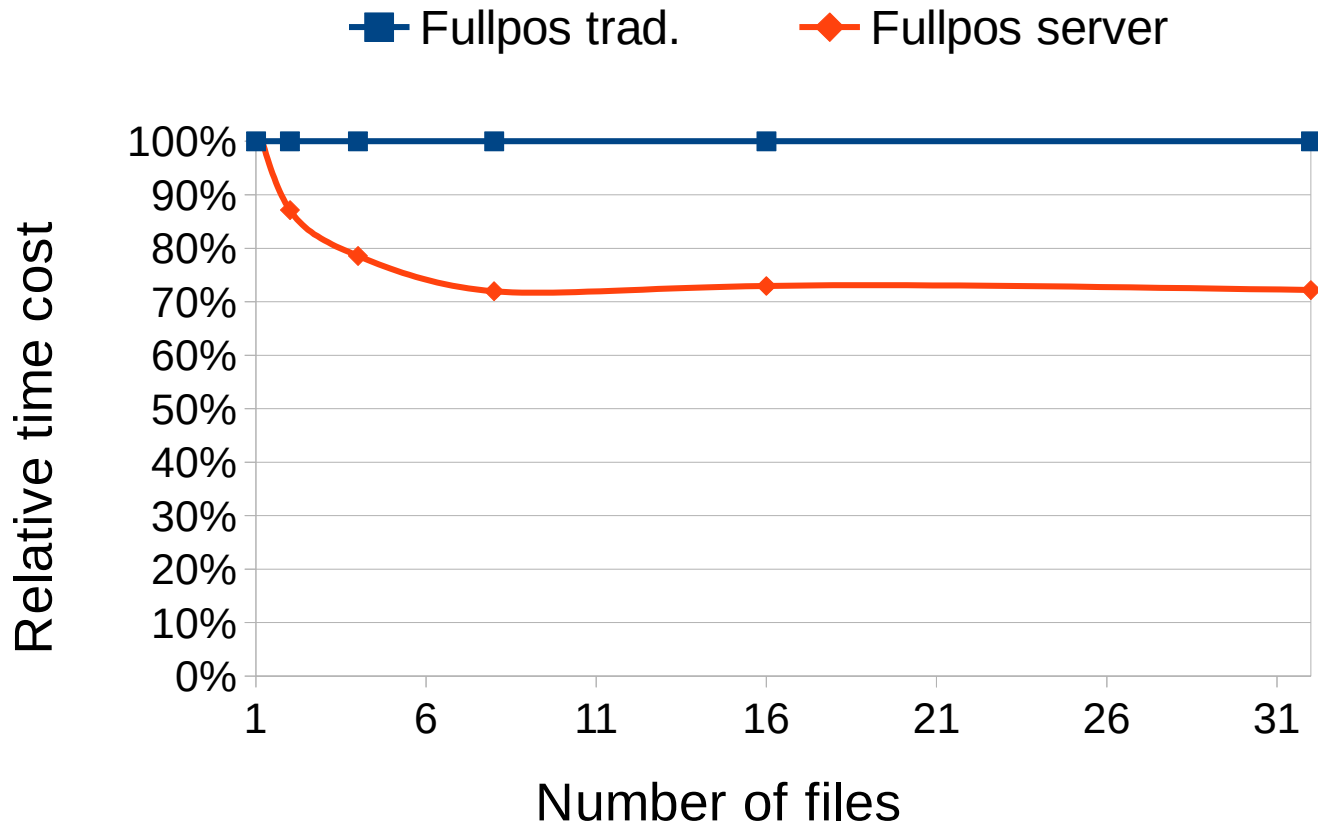

Progressive externalization of Fullpos

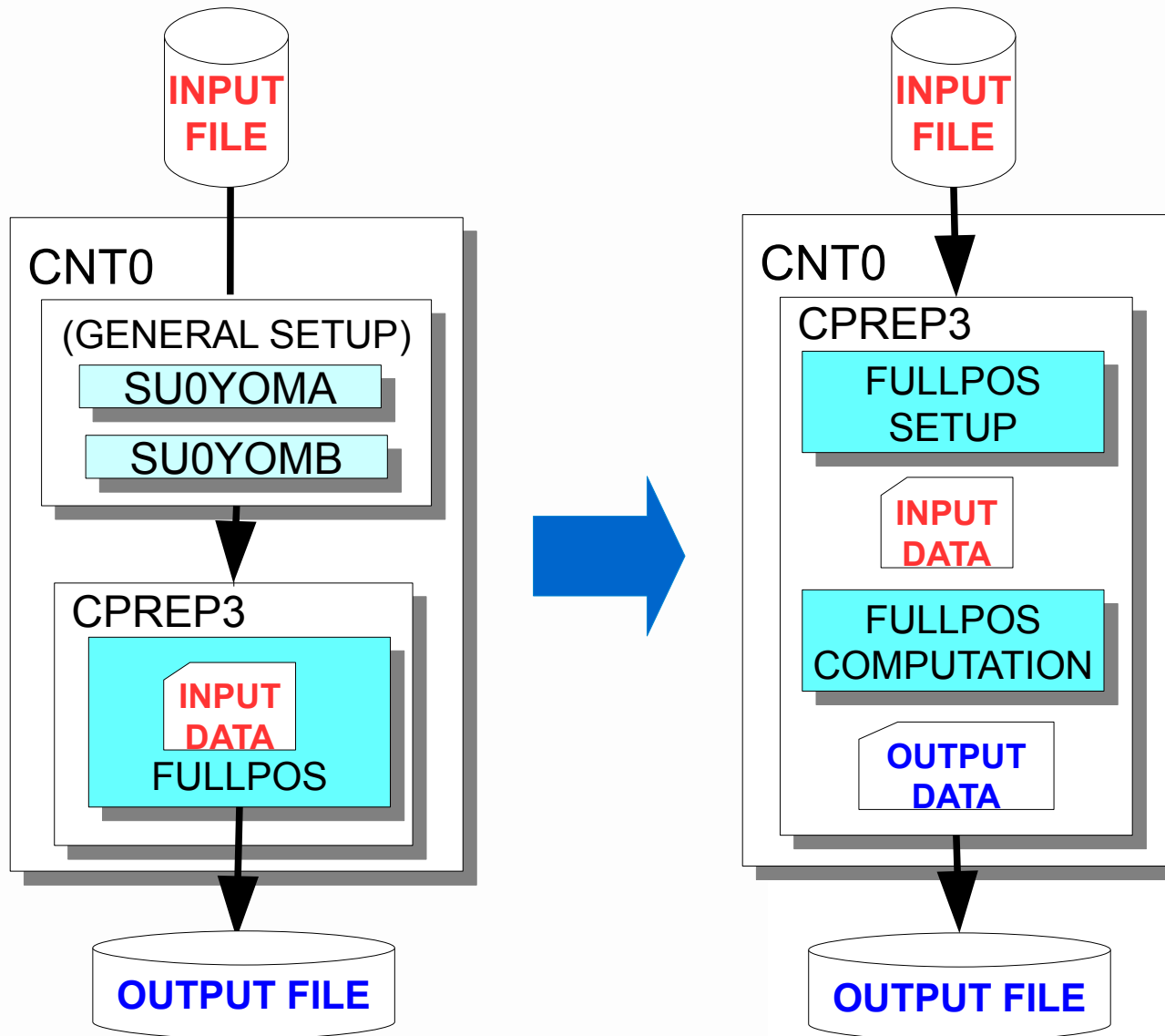

Multi-frequency post-processing

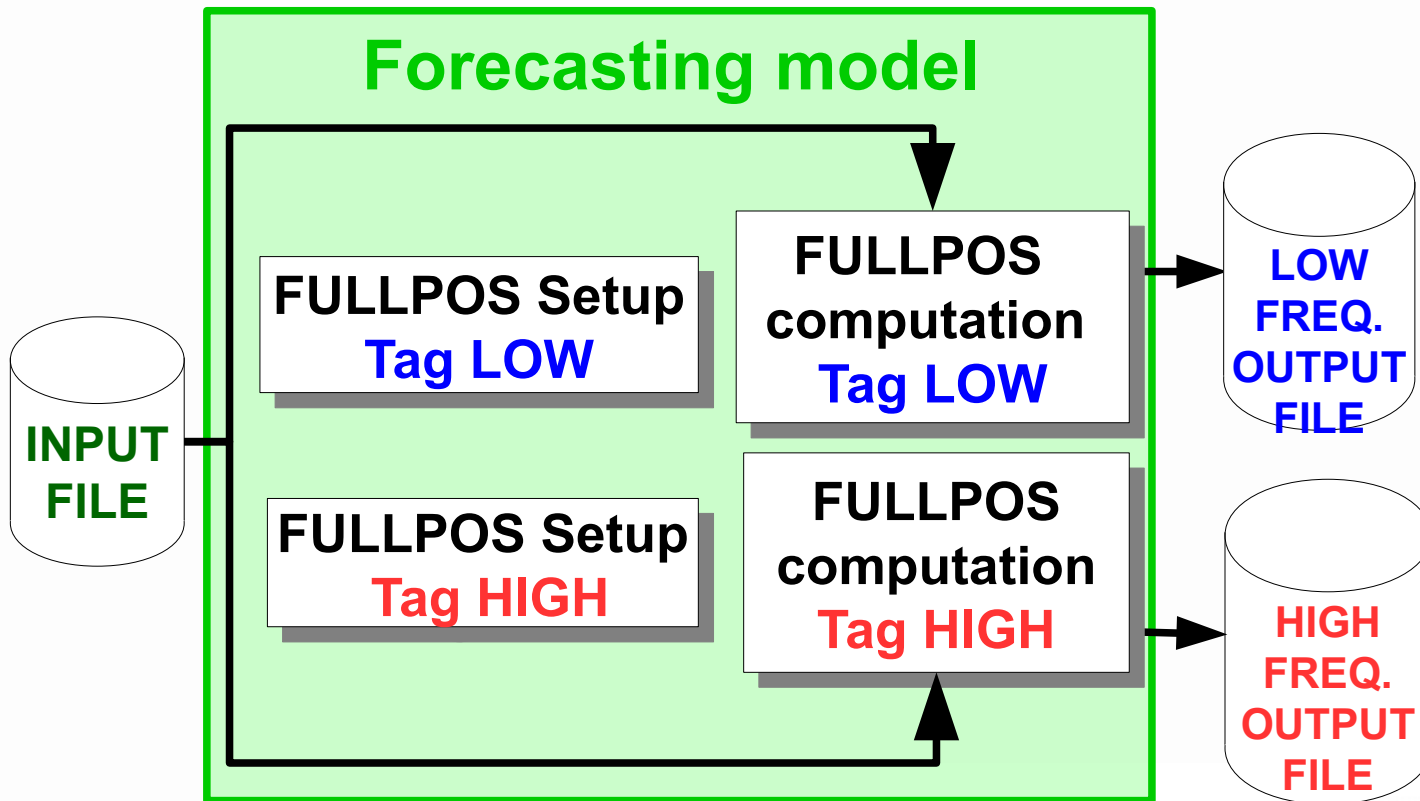

Fullpos-in-OOPS of the poor : use files

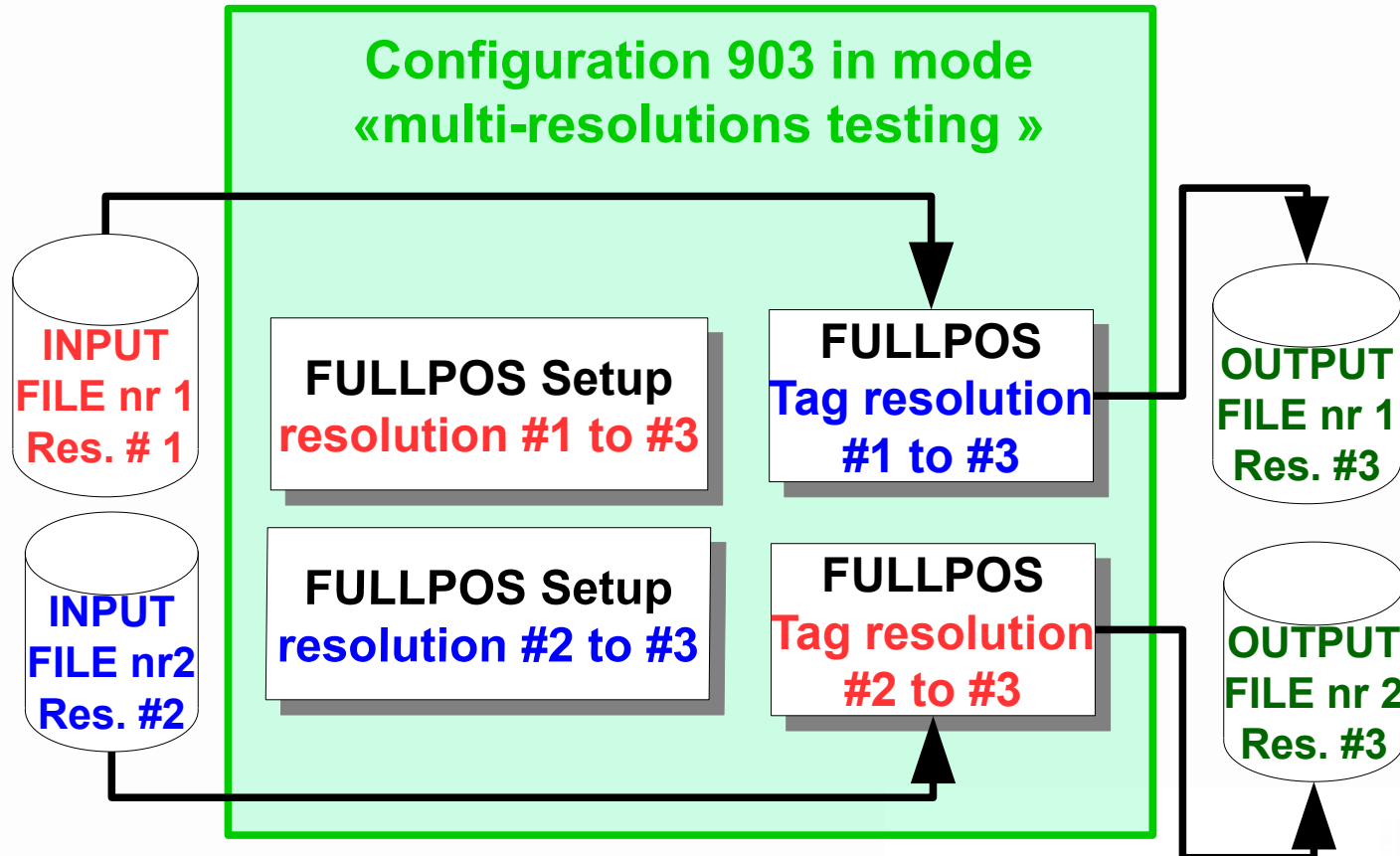

Configuration 903 used to test « pipeline »

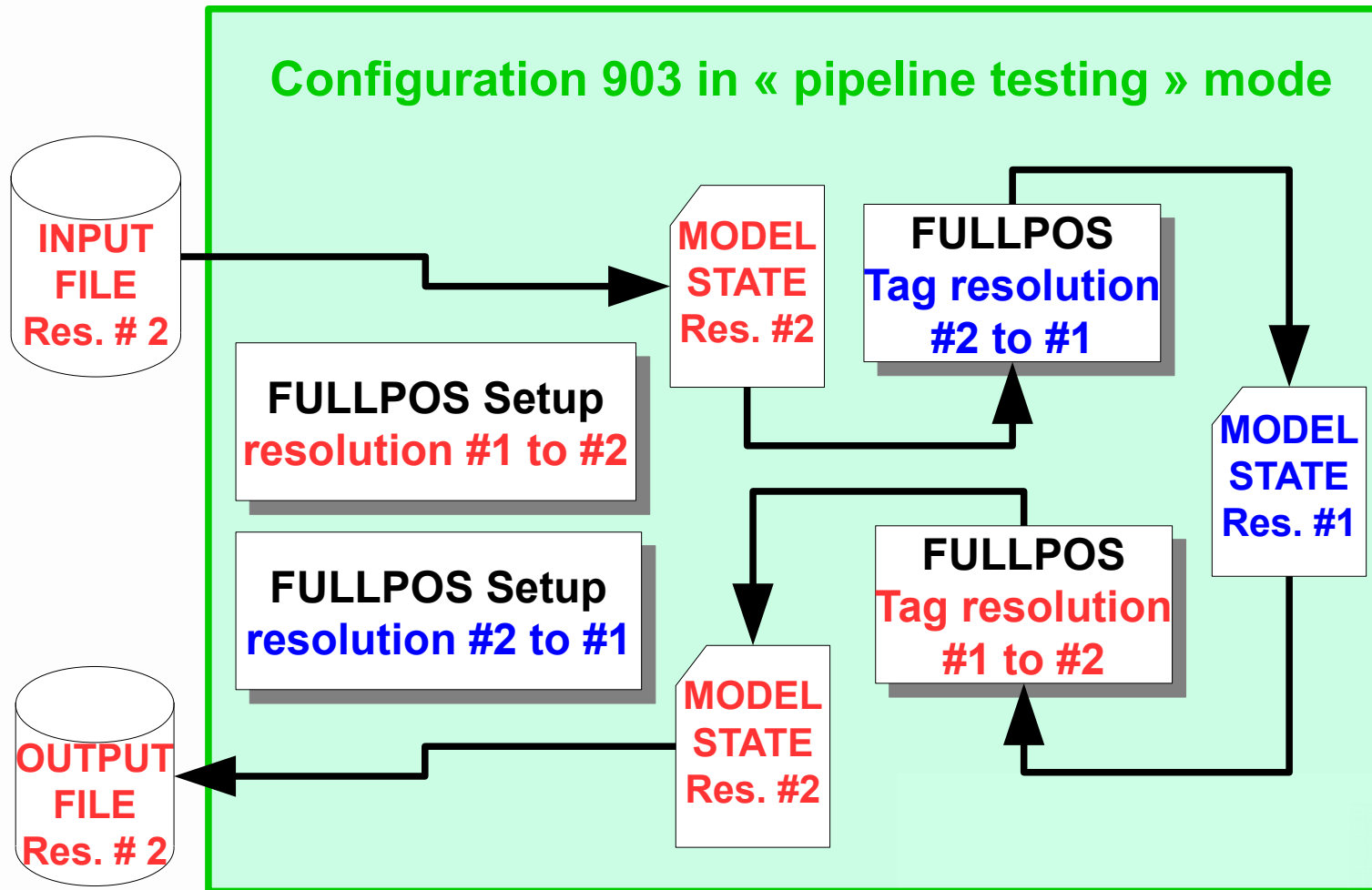

A test of simultaneous instances of Fullpos

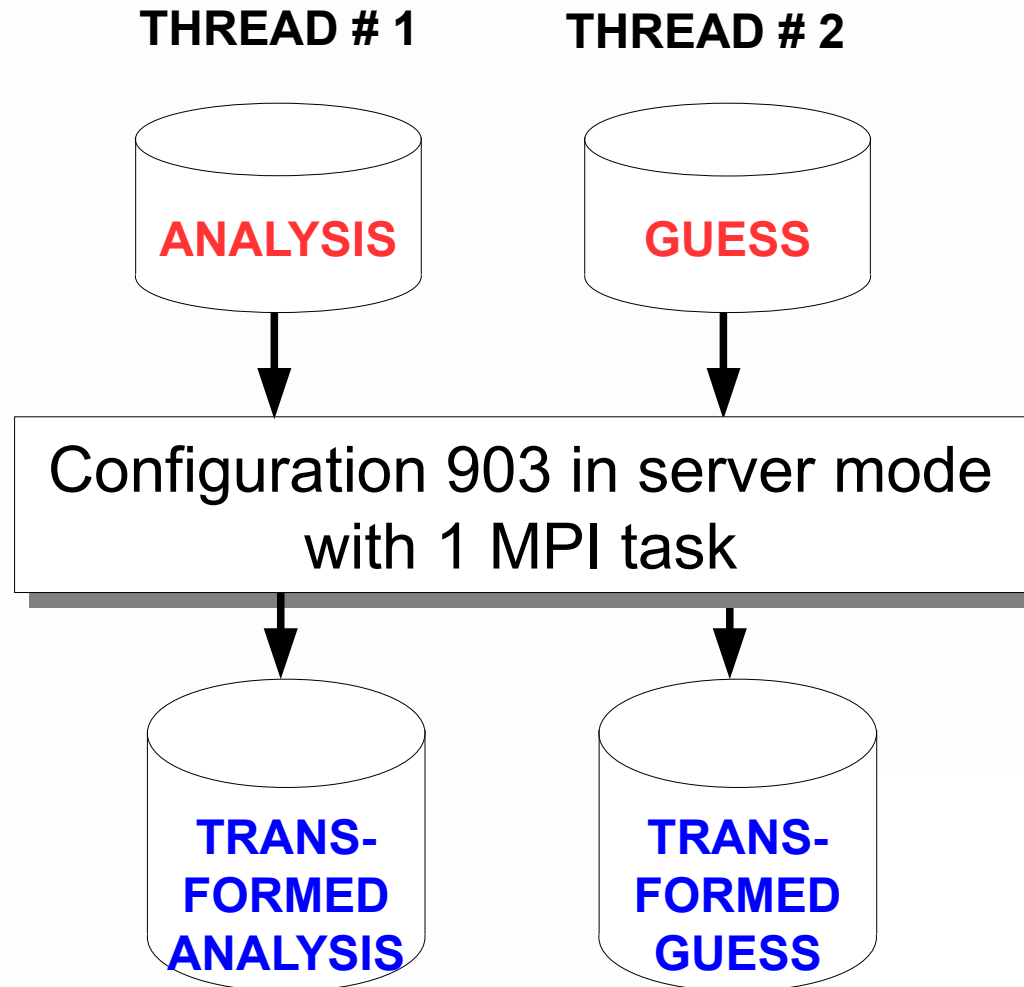

Second generation post-processing servers

Multiple MPI communicators

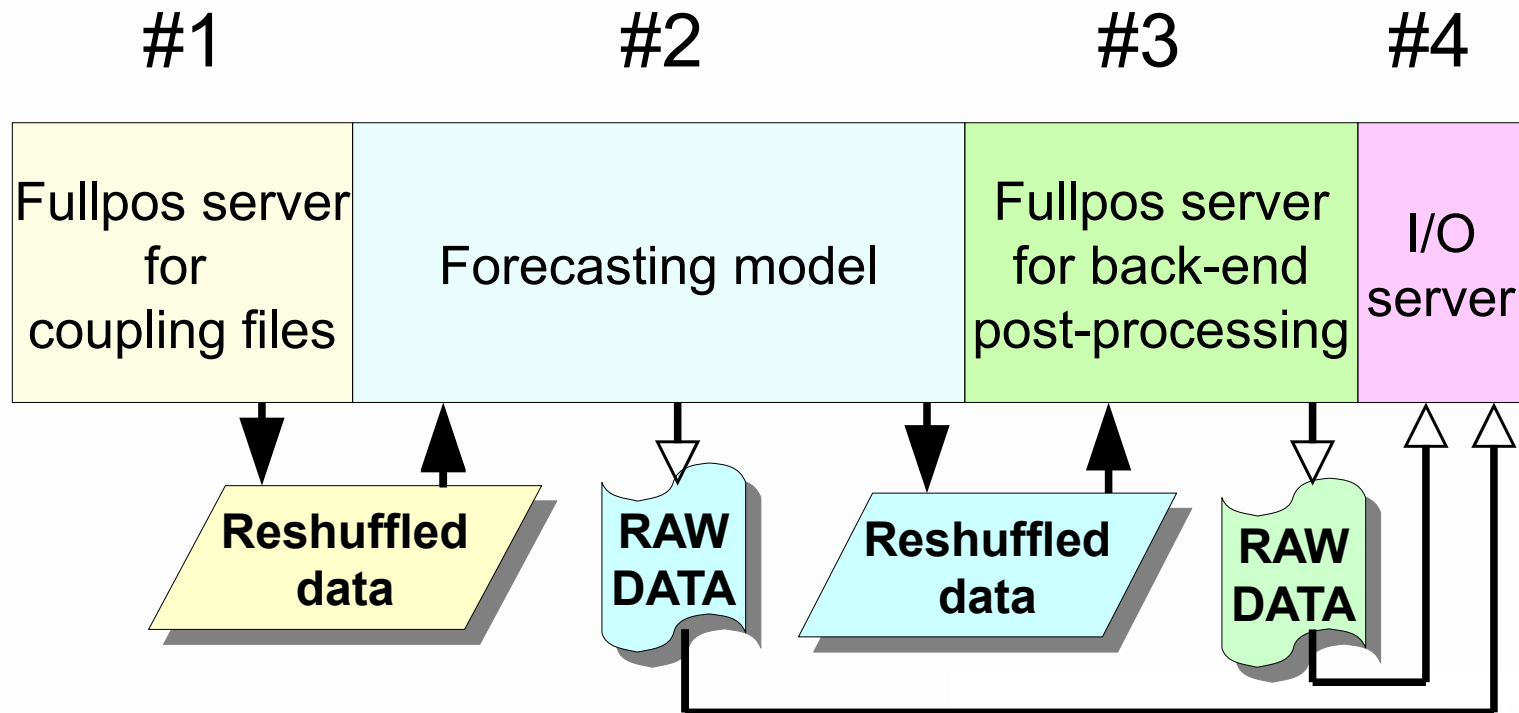

Expected status in cycle 43T1

- Configuration 903 already available for use as basic off-line post-processing in cycle 43
- Configuration 903 in server mode ready for use
 - ✓ Robustness to be confirmed by intensive usage.
 - ✓ Documentation will be sent.
 - ✗ Not yet fully working with the I/O server
- Replacement of the configuration 901 coded ; to be validated (lacks expected here and there !)
- ✗ Interoperability in server mode not ready
- Refactoring for OOPS on its way ...

**Thank you
for your attention !**



**METEO
FRANCE**